



DODGE



Jeep

SRT



First Responders Guide

First Edition

13FFBEV-826-AA

Released: March 28, 2013

©2013 Chrysler Group LLC. All Rights Reserved. FIAT is a registered trademark of Fiat Group Marketing & Corporate Communications S.p.A., used under license by Chrysler Group LLC.

Contents:

- Introduction
- Vehicle Identification
- Vehicle Systems and Components Description
- System Operation
- High Voltage Labels
- Procedures
- **Quick Reference Card**

Pages 32 & 33



Introduction:

This guide provides essential information to help you respond to emergency situations involving the FIAT® 500e. This is a Battery Electric Vehicle (BEV). The intent of this guide is to provide vehicle identification, system description and operation, high voltage labels and procedural information that will allow you to address this vehicle in the safest manner possible. This vehicle has a High Voltage (HV) battery system that contains a large amount of energy. This vehicle does not use petroleum-based fuels.



2013 FIAT® 500e has an electric propulsion system that can deliver an estimated 100 highway miles range of battery-only electric power and zero emissions from a single charge. Charging can be provided by a 120 or 240 Voltage Alternating Current (AC) Electric Vehicle Service Equipment (EVSE) when connected to the vehicle.

Note: The descriptions in this guide reflect the intended design behavior under normal operating conditions. Due care should always be exercised when handling damaged vehicles.

FIAT® 500e Vehicle Identification – Exterior:

FIAT® 500e

The FIAT® 500e has unique badging on the Front, Sides and Rear of the vehicle.

The badging has the following logo:



Front Fascia has concave dimples and round holes.

Both Quarter Panels have concave dimples.

Rear Fascia has many round holes.

FIAT® 500 (Internal Combustion)

The FIAT® 500 with an internal combustion engine has badging on the side Quarter Panels on some models of the vehicle.

The badging has the following logos:



Front Fascia has hexagonal lattice.

Both Quarter Panels are smooth without concave dimples. Some models have raised trim with logo.

Rear Fascia does not have round holes.

FIAT® 500e Vehicle Identification – Exterior Front:

FIAT® 500e



Front Fascia has concave dimples or round holes

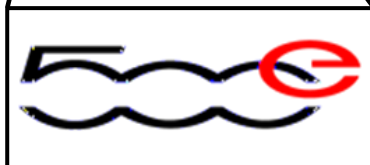

FIAT® 500 (Internal Combustion)



Front Fascia has hexagonal lattice and is without 500e logo

FIAT® 500e Vehicle Identification – Exterior Sides:

FIAT® 500e

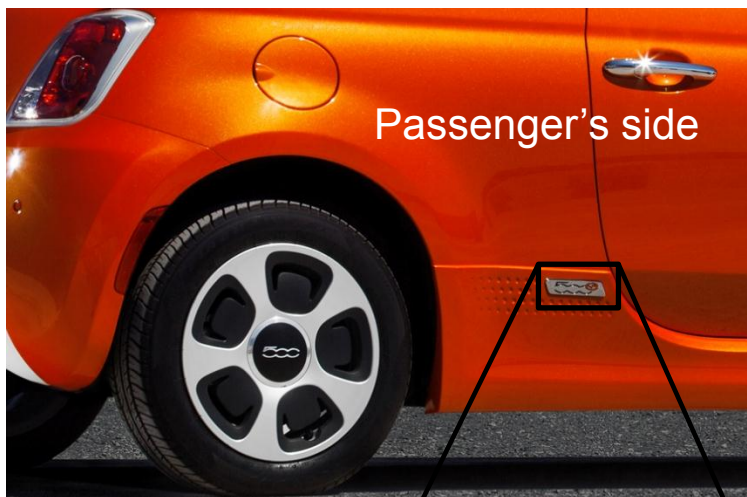

Both Quarter Panels have concave dimples

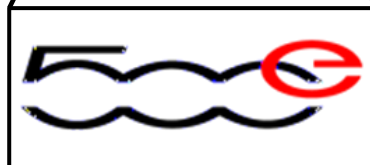

FIAT® 500 (Internal Combustion)

Both Quarter Panels are smooth without concave dimples.

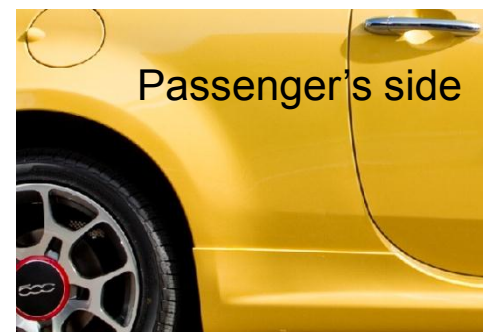

Some models have raised trim with logo

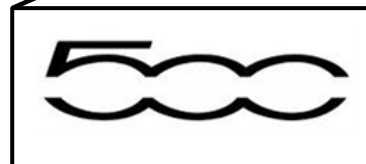

FIAT® 500e Vehicle Identification – Exterior Rear:

FIAT® 500e



Rear Fascia
has round holes

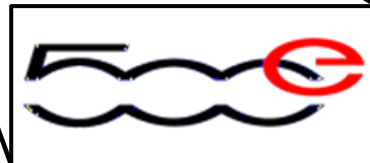

FIAT® 500 (Internal Combustion)



Rear Fascia surface is without round holes

FIAT® 500e Vehicle Identification - Underhood / Interior:

Underhood

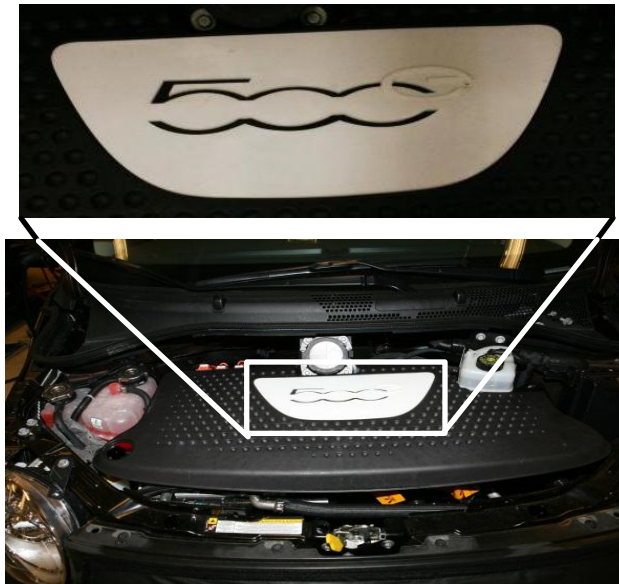

The FIAT 500e vehicle has Underhood Trim Cover and Logo.

Interior

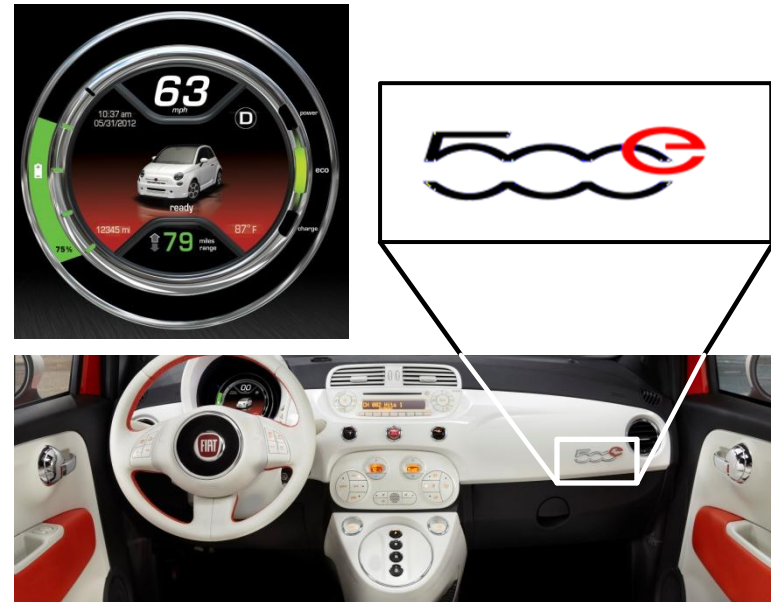

The FIAT 500e instrument cluster has a unique Battery Electric Fuel Gauge and the passenger dash panel has the Logo.

These are unique to the FIAT® 500e and are not on the internal combustion engine version of the FIAT 500.

Vehicle Systems and Components:

The FIAT[®] 500e has the following systems:

- Battery Electric Propulsion Control System
- Electrical Energy Storage System
- HV Battery Plug-in Charging System
- Advanced Thermal Management System
- Supplemental Restraint System – Air Bags

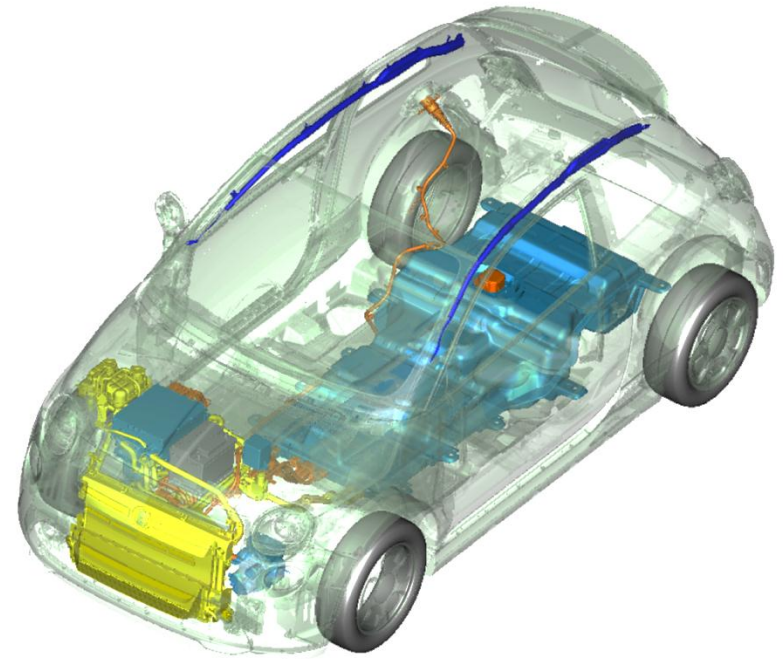

Vehicle Systems and Components:

Battery Electric Propulsion Control System

83 kW of electric drive motor peak power

1918 Nm of maximum torque at the front wheels

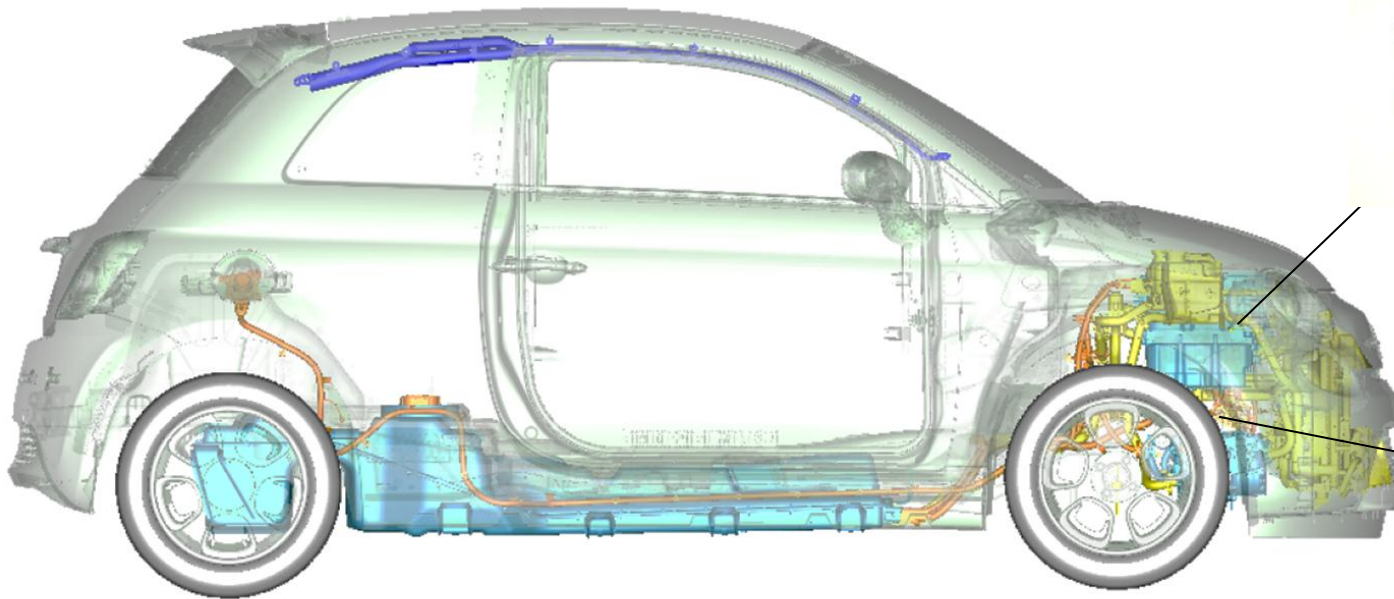

Power Electronics

- Electric Drive Motor
- Generator Function



Electric Drive Motor



Vehicle Systems and Components:

Electrical Energy Storage System

HV Battery System

12 V Battery

12 V Battery

- Lead Acid Technology

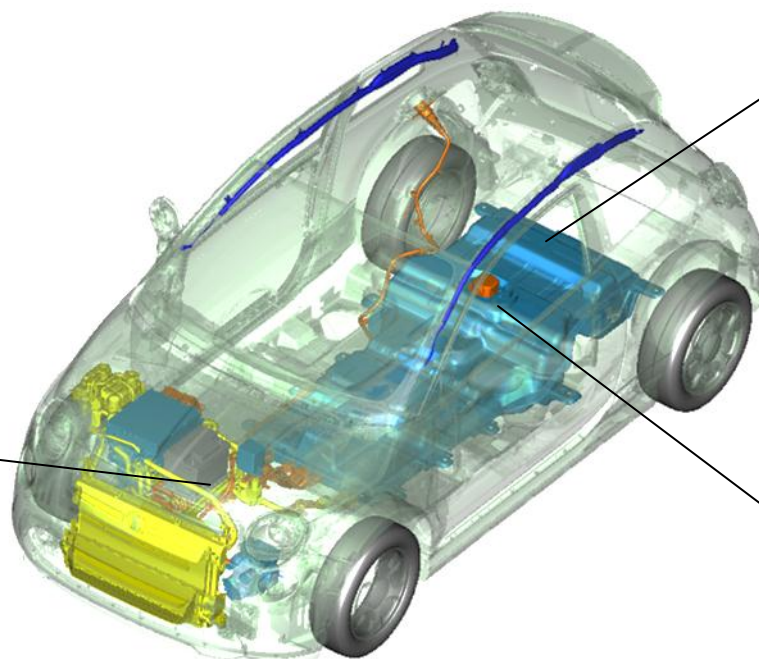

HV Battery System

- Lithium-Ion (Li-Ion)
- 400 VDC
- 24 kWhr
- Liquid Cooled



Service Disconnect

- At the HV Battery



Vehicle Systems and Components:

HV Battery Plug-in Charging System

120 and 240 VAC charging capabilities

EVSE SAE Level 1 and 2 Charging

Onboard Charger

- 120 VAC
- 240 VAC

Vehicle Charge Receptacle

- EVSE Recharge Coupler

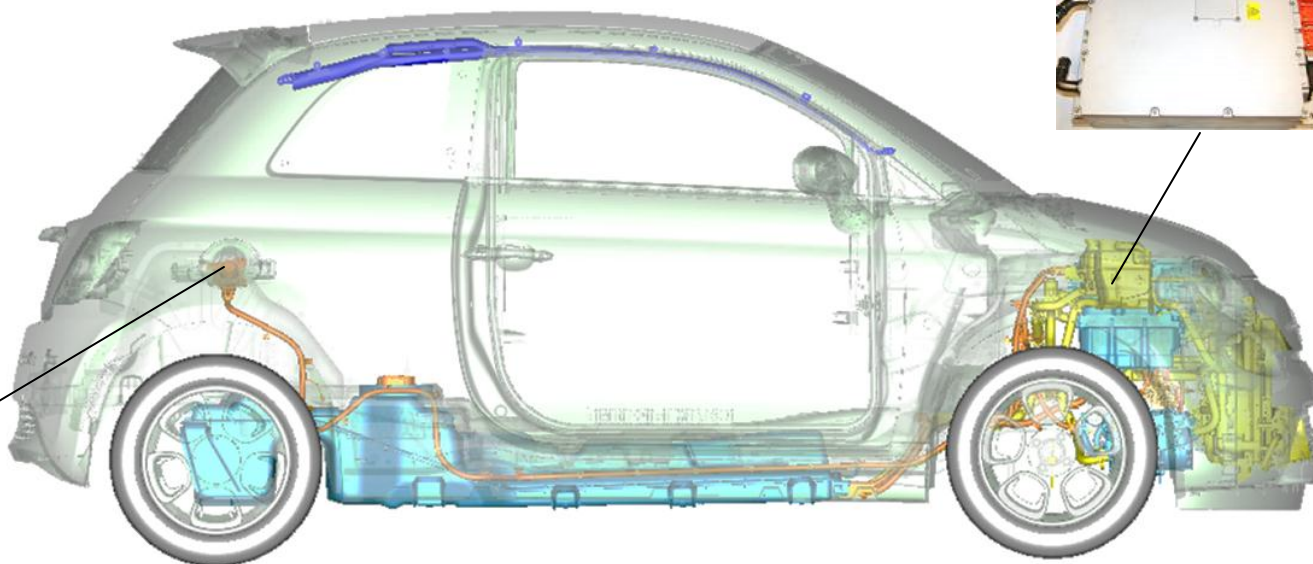

Vehicle Systems and Components:

Advanced Thermal Management System

Heating, Ventilation, and Cooling (HVAC) Compressor

HVAC Heater

Battery Coolant Heater

Thermal Management

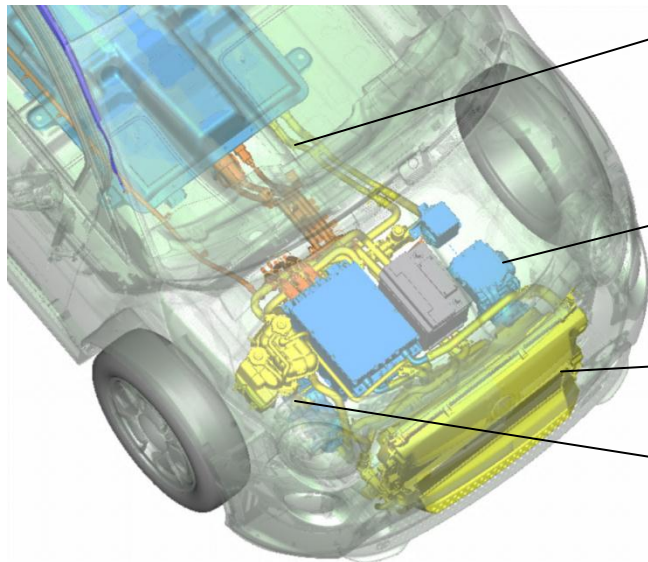

**HVAC
Heater**



**HVAC
Compressor**

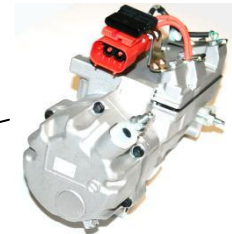

Thermal Systems

- Power electronics
- HV Battery

**Battery
Coolant
Heater**

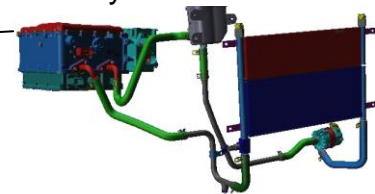

Vehicle Systems and Components:

Supplemental Restraint System – Air Bags

Vehicle occupants are protected by seven airbags, including driver and multistage front-passenger advanced airbags, driver's knee airbag, full-length side-curtain airbags and seat-mounted pelvic-thorax airbags.

The airbags and sensing system are powered by the 12 V battery.

System Operation - Electric Propulsion

The FIAT® 500e is a Battery Electric propulsion vehicle. Propulsion is provided by an electric motor with energy provided by the HV Battery System.

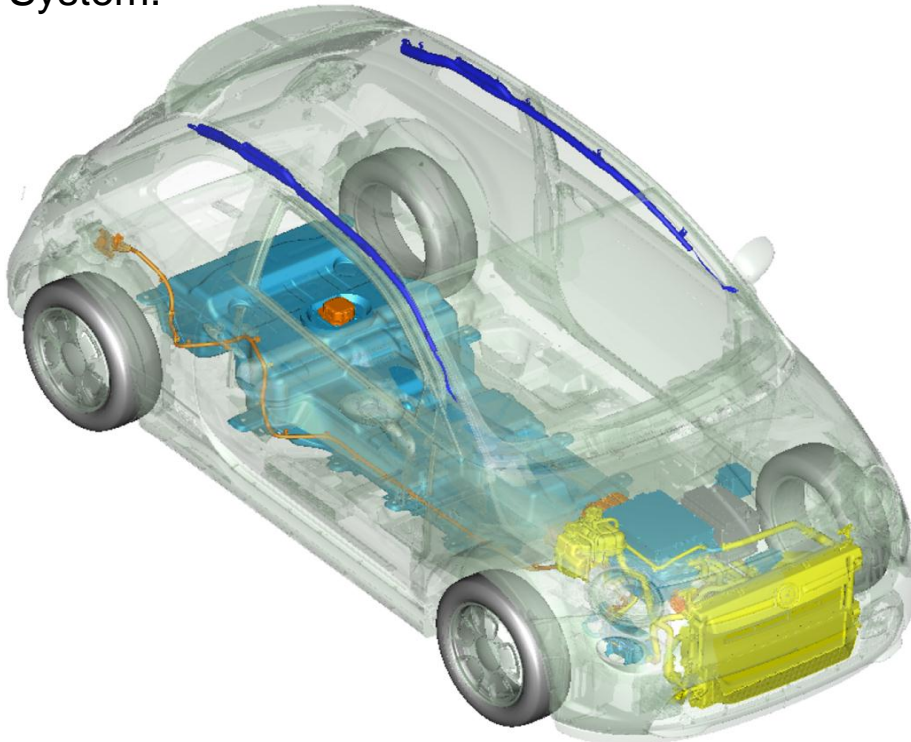

This vehicle does not use petroleum-based fuels and does not have an internal combustion engine to propel the vehicle.

Energy from the HV Battery System provides the power to the electric motor for vehicle propulsion.

The vehicle control system uses the electric motor to do regenerative braking and recover some of the energy during vehicle braking. This energy is put back into the HV Battery System. Both regenerative and friction braking are used to stop the vehicle when conditions are appropriate.

System Operation - High Voltage

The FIAT® 500e High Voltage (HV) Battery System always contains HV. When HV is external of the HV Battery System it is called “Live HV”.

The FIAT 500e can have Live HV whenever the key is in the ignition. Also, under normal operating conditions the vehicle can have HV power external of the HV Battery System for up to 2 minutes following when any door is opened, key is removed from the ignition or by the remote keyless entry activation.

The FIAT 500e is designed to control access to Live HV. A damaged vehicle or improperly maintained vehicle may not have controlled access to Live HV.

The FIAT 500e uses HV power to provide propulsion, HVAC cooling and heating, and battery coolant heater functions. These functions are external of HV Battery System. These functions are contained within HV Components and HV Cables and may contain HV power after the ignition is turned off.

The HV Battery System uses HV contactors to contain the HV energy within the HV Battery System. Under normal circumstances the HV Contactors provide separation. However, the HV Contactors may not function as designed as a result of a crash event or other conditions. Consequently, HV may not be contained within the HV Battery System. Exposure to the presence of Live HV can cause serious injury or death.

First Responders shall use proper Personal Protection Equipment when addressing a damaged FIAT® 500e vehicle.

System Operation - Stored HV Energy

Stored HV energy in the HV Battery System is provided to the Power Electronics and delivered as three phase AC power to the Electric Motors for propulsion. This stored HV energy is used by the HVAC Compressor, HVAC Heater, and Battery Coolant Heater to provide heating and cooling to the passenger compartment and HV Battery System. Also, the stored HV energy is used by the Power Electronics to provide the Generator Function that transfers power to the 12 V Battery.

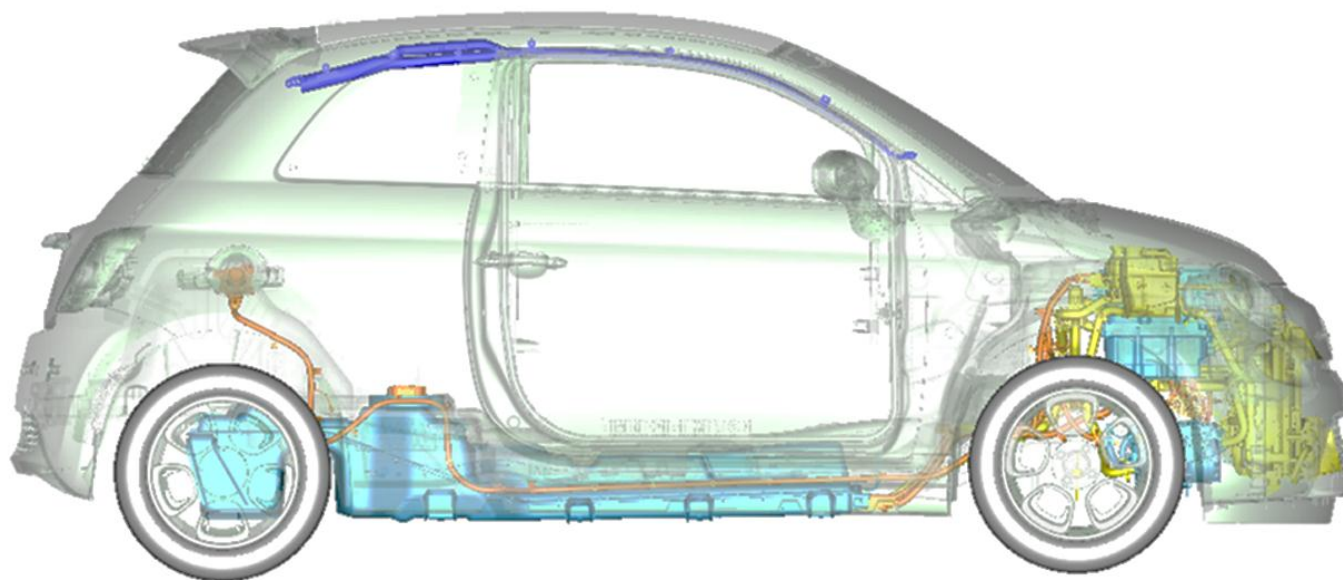

System Operation - Plug-In Charging

Plug-in charging of the HV Battery System can be initiated by connecting the EVSE Recharge Coupler into the vehicle Charge Receptacle. Optionally, charging can be delayed or scheduled for a later start time. This may result in HV power-up without warning.

While the Recharge Coupler is connected to the vehicle Charge Receptacle the transmission is locked in park. The vehicle can not be shifted out of park. Also, one or more vehicle Charge Indicator Lights on the top of the dash panel will be illuminated. The number of vehicle Charge Indicator Lights depending on HV Battery System state of charge status.

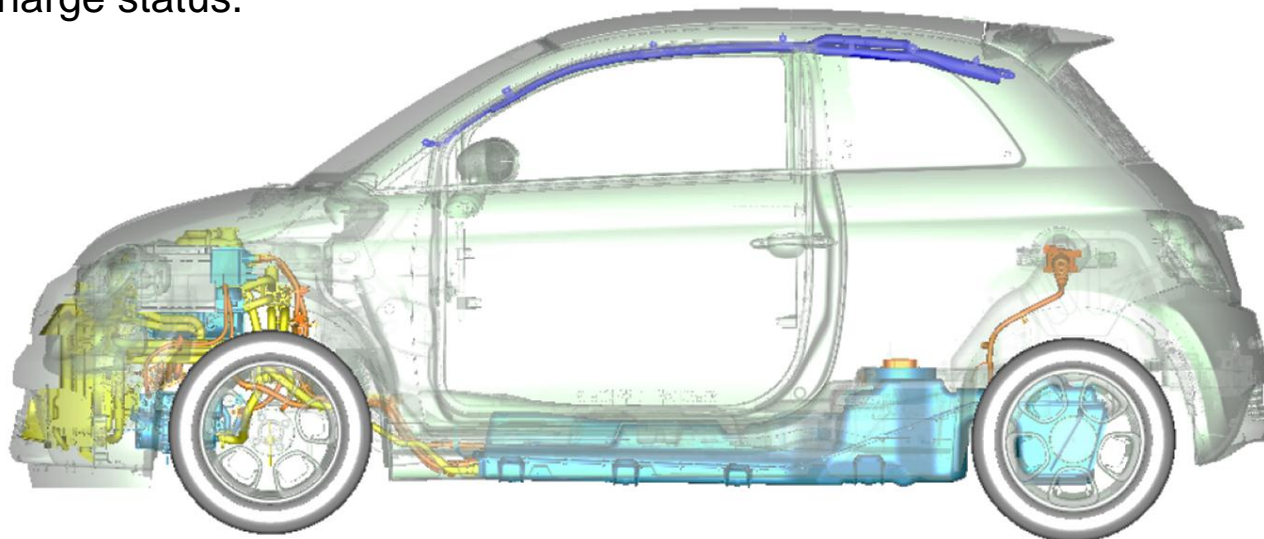

System Operation - Restored HV Energy

HV Battery System energy can be restored during Plug-in Charging or regenerative braking.

During Plug-in charging the power from the EVSE Recharge Coupler flows through the vehicle Charge Receptacle to the Onboard Charger. The Onboard Charger converts AC to Direct Current (DC). DC flows to the HV Battery System and increases the state of charge.

During regenerative braking, the three phase AC generated by the Electric Drive Motor is converted to DC by the Power Electronics. DC flows to the HV Battery System and increases the state of charge.

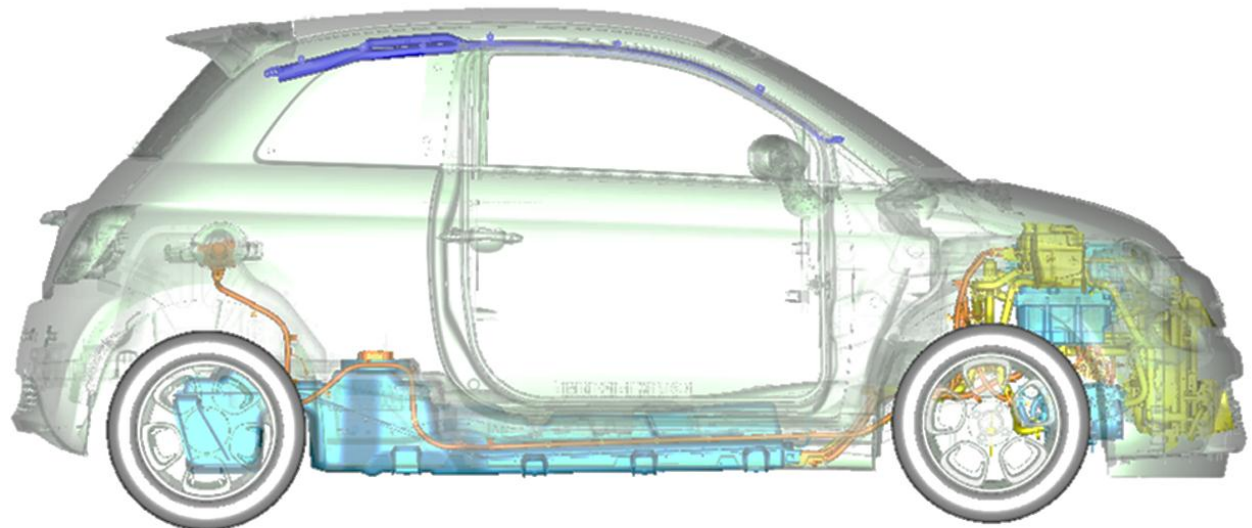

System Operation (Supplemental Restraint System)

The Supplemental Restraint System is designed to detect certain front, side and rear vehicle impact conditions. When appropriate, the impact sensing system deploys the Air Bags, signals the Electric Vehicle Control System and the HV Battery System opens the HV contactors. These contactors contain HV with the HV Battery System. The electrical energy contained within the High Voltage Battery is not dissipated.

Operation of the Air Bag System is powered from the 12 V battery. The Supplemental Restraint System is designed to discharge two minutes after 12 V power is removed.

System Operation (Flow of Electrical Energy)

The electrical energy, AC or DC flows through HV cables between HV components. All orange cables can contain Live HV.



The HV Battery System has HV Contactors designed to contain electrical energy within the HV Battery System. These HV Contactors are controlled by the 12 Volt system. By design, when Ignition key is turned off or 12 Volt Battery is disconnected then the HV Contactors open and HV is contained within the HV Battery System. Also, Live HV cannot flow through the HV Cables or HV Power Distribution Center to HV components.

There is a Service Disconnect for the HV Battery System located under the second row seat cushion. It is part of the electrical circuit and must be connected if electrical energy is to flow through the HV cable from the HV Battery System. By Design, removal of the Service Disconnect inhibits the flow of electrical energy from the HV Battery System.



Warning: The HV Contactors and Service Disconnect may not function as designed as a result of a crash event or other conditions. Consequently, HV may not be contained within the HV Battery System. Exposure to the presence of Live HV can cause serious injury or death.

High Voltage Labels – On HV Components

All High Voltage components are identified by a four symbol Label.



Attention symbol



HV Hazard symbol



Reference to the Owner's Manual symbol



Electrical Shock Hazard symbol

FIAT First Responders Guide

High Voltage Labels – On HV Components

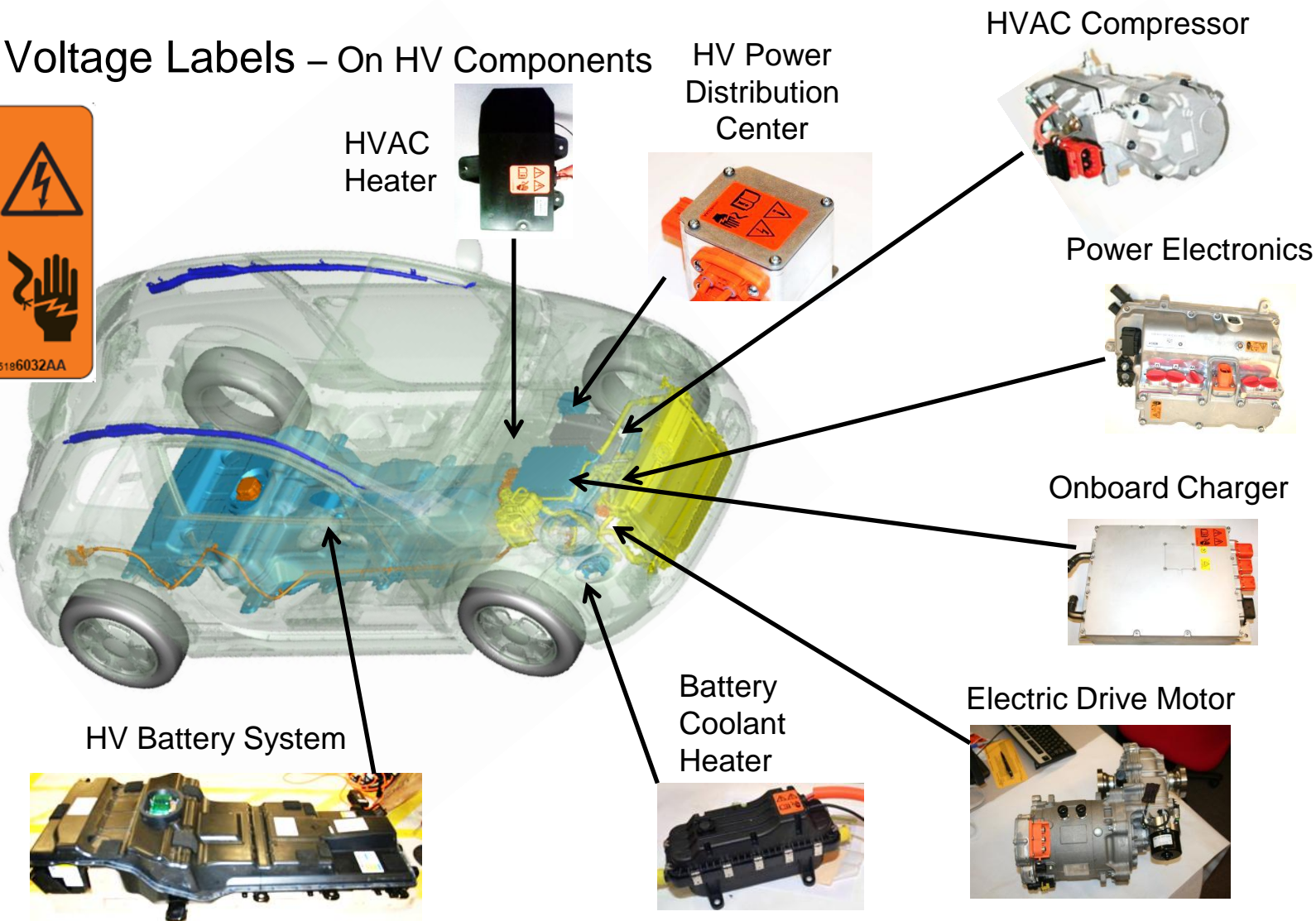

Procedures - Disable 12 V and High Voltage (HV)

To disable utility power to the vehicle do step 1. To disable 12 V power from the Vehicle Systems and to disable HV Battery power external from the HV Battery complete steps 2 AND 3. Step 4 is an option and only disables HV Battery power external of the HV Battery. Step 5 allows the charge on HV capacitors to be discharged.

The following steps must be completed in numeric order:

1. Unplug the EVSE Recharge Coupler from the Vehicle Charge Receptacle, this will stop the AC power transfer to the vehicle. Press the Recharge Coupler button and pull to remove or turn off power to the EVSE.
2. Turn off and remove Ignition Key, this will start the process of disabling 12 V and HV power.
3. Physically cut the 12 V power from the vehicle, this will disable 12 V and HV power external of the HV Battery. Remove a segment of each cable attached to the 12 V battery negative terminal. Followed by removal of a segment of each cable attached to the 12 V battery positive terminal. Cut the negative cables then the positive cables.
4. (Optional) Remove the Service Disconnect from under the second row seat. This will only disable HV external of the HV Battery System.
5. Wait 5 minutes to allow HV capacitors external of the HV Battery to discharge before addressing a damaged vehicle.

Procedure Step 1:

Unplug the EVSE Recharge Coupler from the Vehicle Charge Receptacle

This will remove EVSE AC power from the vehicle.

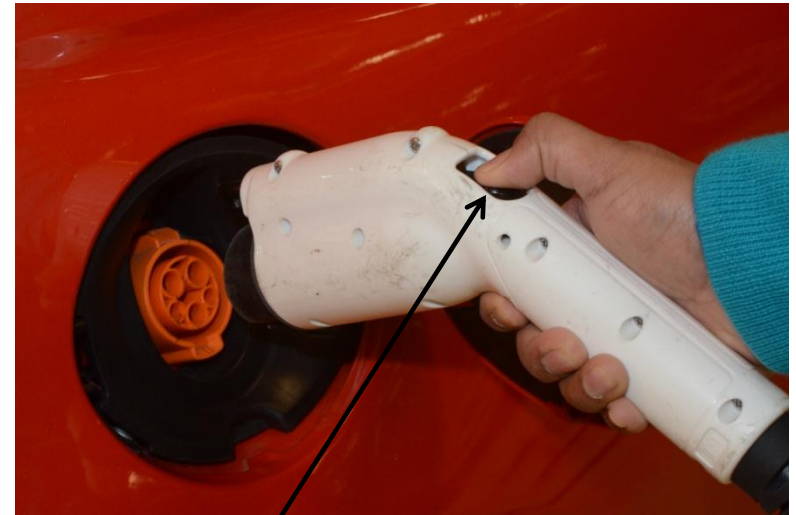

Press the EVSE Recharge Coupler button and pull to remove

Procedure Step 2:

Turn Off and Remove Ignition Key

This action starts disabling of 12 V and HV.



Turn Ignition Switch to off and remove the Key

Procedure Step 3:

Physically cut the 12 V power

These actions initiate the disabling of 12 V and HV Power.

First Responders Label as seen in vehicle



or



First:

Remove Trim Cover to reveal the 12 V Battery.

Second:

At the 12 V Battery Negative terminal, cut and remove a segment of each attached cable.

All three cables have First Responders Label designating the cut locations.

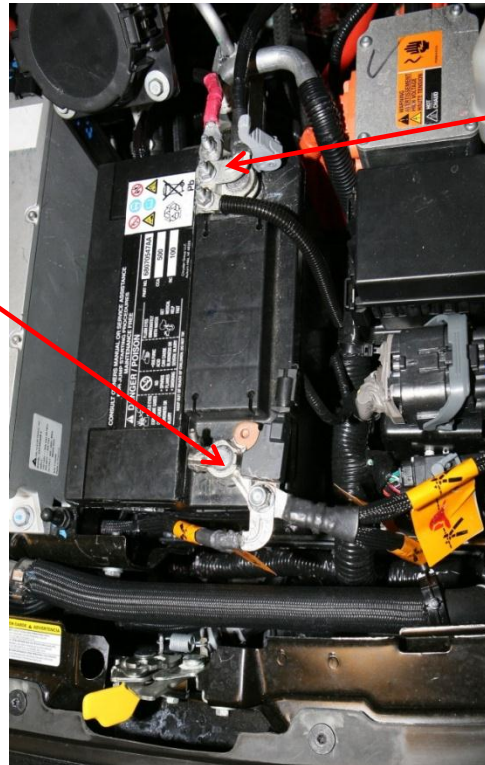

Third:

At the 12 V Battery Positive terminal, cut and remove a segment of each attached cable.

The critical cable is identified with a First Responders Label designating the cut location.

Procedure Step 4: (Optional)

Remove the Service Disconnect

This starts to disable Live HV.



First: Remove second row seat cushion to reveal Service Disconnect cover.

Second: Remove cover to reveal the Service Disconnect.



Third:
Remove
Service
Disconnect



Procedure Step 5:

Wait 5 minutes

This will allow the HV capacitors to discharge under most circumstances. However, under some circumstances the HV Battery System HV Contactors may not open. Consequently, HV may not be contained within the HV Battery System.

Personal Protection Equipment (HV qualified Gloves, Boots and Coat) provides protection against Live HV.

Warning: Personal Protection Equipment must be used by First Responders when addressing a damaged FIAT® 500e.

Procedures - Vehicle Do NOT Cut Zones

Do NOT Cut Zones:
Include areas where HV
Cables, HV Components
and Curtain Airbags are
located. Shown as **Xs**.

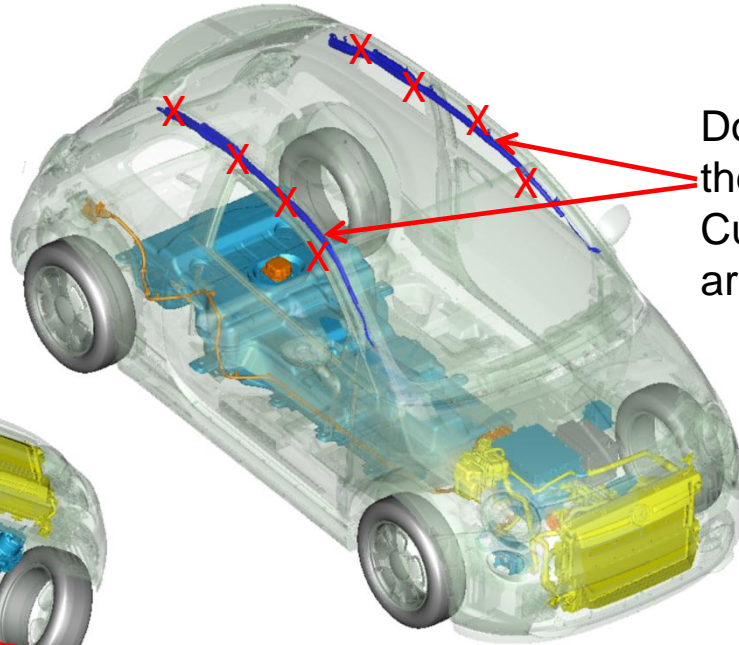

Do NOT cut in
the areas where
Curtain Airbags
are located.

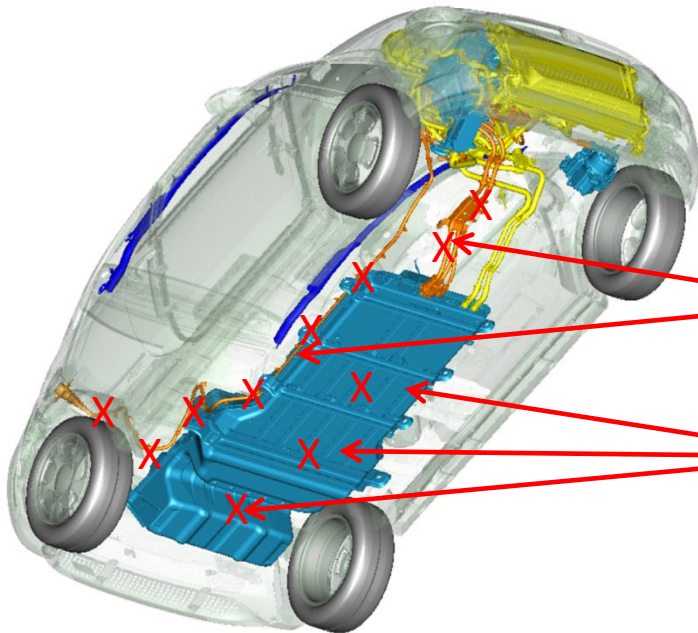

Do NOT cut the
orange HV Cables

Do NOT cut HV Battery
System as shown as visible
from under the body of the
vehicle.

Procedures - Water Considerations

A vehicle submerged or flooded with water can result in system failure. Excessive heat and electrolysis may take place resulting in byproducts of hydrogen and oxygen. In salt water chlorine is also a byproduct. These byproducts, if contained, may be in concentrations that may be explosive or corrosive and could have adverse affects on the human body.

A vehicle **without** impact damage has HV contained within enclosures or insulation and has HV isolated from the chassis, therefore electrical shock hazard risk is minimal. A submerged or flooded undamaged vehicle has a low electrical shock hazard risk.

A vehicle **with** impact damage presents an increased electrical shock hazard risk. If HV is open to the environment you must stay away from damaged HV components.

Warning: First Responders must use proper Personal Protection Equipment when addressing a damaged FIAT® 500e vehicle.

Procedures - Fire Considerations

The HV Battery System has a Li-Ion chemistry. This battery, if on fire, has a low risk of exploding. The chemistry contains an oxidizer. Once this battery has started burning, it will try to burn to completion. The best intervention is to apply and continue to apply water to cool and quench the burning material. ABC extinguisher is not recommended.

**Water use
is
Recommended**



**ABC Fire
Extinguisher
is Not
Recommended**

Quick Reference Card side 1

Vehicle Identification

Exterior Overview

FIAT® 500e

The FIAT® 500e has unique badging on the Front, Sides and Rear of the vehicle.

The badging has the following logo:



Front Fascia has concave dimples and round holes.

Both Quarter Panels have concave dimples.

Rear Fascia has many round holes.

FIAT® 500 (Internal Combustion)

The FIAT® 500 with an internal combustion engine has badging on the side Quarter Panels on some models of the vehicle.

The badging has the following logos:



Front Fascia has hexagonal lattice.

Both Quarter Panels are smooth without concave dimples. Some models have raised trim with logo.

Rear Fascia does not have round holes.

Exterior Front

FIAT® 500e



Front Fascia has concave dimples or round holes



FIAT® 500 (Internal Combustion)



Front Fascia has hexagonal lattice and is without 500e logo

Exterior Rear

FIAT® 500e



Rear Fascia has round holes



FIAT® 500 (Internal Combustion)



Rear Fascia surface is without round holes

Exterior Sides

FIAT® 500e



Both Quarter Panels have concave dimples



FIAT® 500 (Internal Combustion)

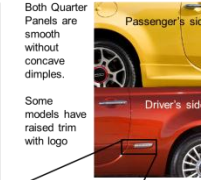

Both Quarter Panels are smooth without concave dimples.

Some models have raised trim with logo



Underhood



The FIAT 500e vehicle has Underhood Trim Cover and Logo.

Interior



The FIAT 500e instrument cluster has a unique Battery Electric Fuel Gauge and the passenger dash panel has the Logo.

These are unique to the FIAT® 500e and are not on the internal combustion engine version of the FIAT 500

High Voltage Components

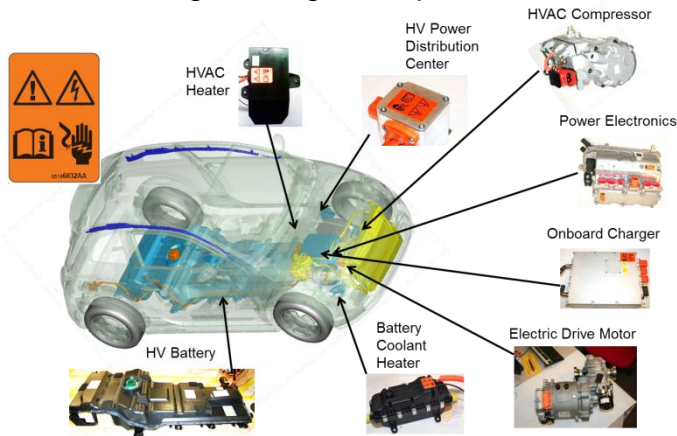

No Cut Zones

Do not Cut Zones: Include areas where HV Cables, HV Components and Curtain Airbags are located. Shown as Xs.

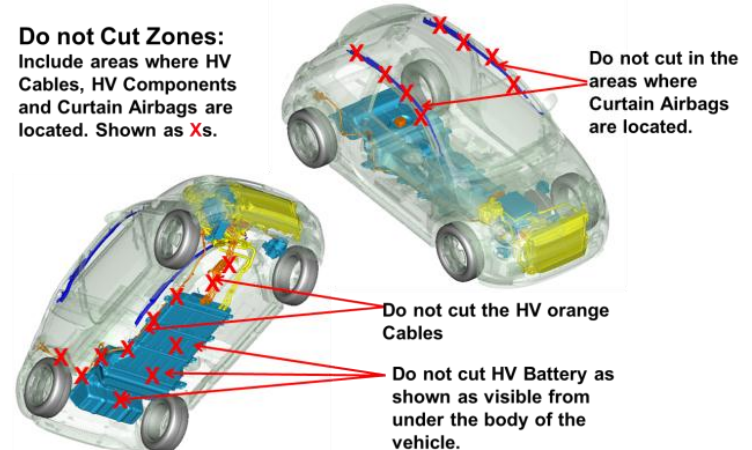

Quick Reference Card side 2

Disabling the Low Voltage (12 Volt) and High Voltage System

Procedures - Disable 12 V and High Voltage (HV)

To disable utility power to the vehicle do step 1. To disable 12 V power from the Vehicle Systems and to disable HV Battery power external from the HV Battery complete steps 2 AND 3. Step 4 is an option and only disables HV Battery power external of the HV Battery. Step 5 allows the charge on HV capacitors to be discharged.

The following steps must be completed in numeric order:

1. Unplug the EVSE Recharge Coupler from the Vehicle Charge Receptacle, this will stop the AC power transfer to the vehicle. Press the Recharge Coupler button and pull to remove or turn off power to the EVSE.
2. Turn off and remove Ignition Key, this will start the process of disabling 12 V and HV power.
3. Physically cut the 12 V power from the vehicle, this will disable 12 V and HV power external of the HV Battery. Remove a segment of each cable attached to the 12 V battery negative terminal. Followed by removal of a segment of each cable attached to the 12 V battery positive terminal. Cut the negative cables then the positive cables.
4. (Optional) Remove the Service Disconnect from under the second row seat. This will only disable HV external of the HV Battery System.
5. Wait 5 minutes to allow HV capacitors external of the HV Battery to discharge before addressing a damaged vehicle.

Step 1: Unplug the EVSE Recharge Coupler from the Vehicle Charge Receptacle

This will remove EVSE AC power from the vehicle.



Press the EVSE Recharge Coupler button and pull to remove

Step 2: Turn Off and Remove Ignition Key



Step 3: Physically cut the 12 V Power

These actions initiate the disabling of 12 V and HV Power.



First:
Remove Trim Cover to reveal the 12 V Battery.

Second:
At the 12 V Battery Negative terminal, cut and remove a segment of each attached cable.
All three cables have First Responders Label designating the cut locations.

First Responders Label as seen in vehicle



Third:
At the 12 V Battery Positive terminal, cut and remove a segment of each attached cable.
The critical cable is identified with a First Responders Label designating the cut location.

Step 4: (Optional) Remove the Service Disconnect

This starts to disable Live HV.



First: Remove second row seat cushion to reveal Service Disconnect cover.

Second: Remove cover to reveal the Service Disconnect.

Third: Remove Service Disconnect

Step 5: Wait 5 Minutes